

# Product data

Dimensions, technical information and performance specification

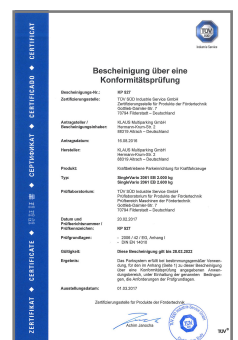

## singlevario 2061



## Table of contents

Explanation of symbols.....	2	Access incline.....	8
Parking positions.....	2	Clearance for installations.....	8
Dimensions and tolerances.....	2	Electrical installation.....	9
Overview of building configuration.....	3	CE conformity.....	10
Vehicle data.....	3	Technical information.....	11
Overview of system types and building heights.....	4	Performance specification.....	12
Width dimensions.....	5	Services to be provided by the customer.....	13
Width dimension with door.....	5	Subject to technical changes.....	13
Width dimension without door.....	6		
Loading schedule.....	7		

## Explanation of symbols



Platforms accessible horizontally.



max. load per parking space in kg.  
Upweighting over 2000 kg possible with surcharge (see "Vehicle data", page 3).



Height can be subsequently adjusted (see "Overview of system types and building heights", page 4).  
Parking space load can be subsequently upweighted (see "Vehicle data", page 3).



The systems provided are consistent with DIN EN 14010 and the EC Machinery Directive 2006/42/EC.



This system has also undergone a voluntary compliance test conducted by TÜV SÜD.

## Parking positions

### Lower parking space

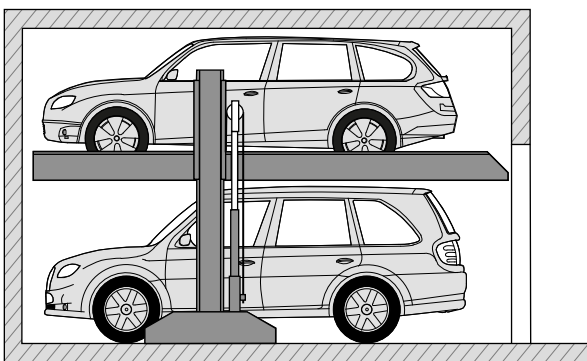

The lower vehicle can park in or leave the parking space.

### Upper parking space

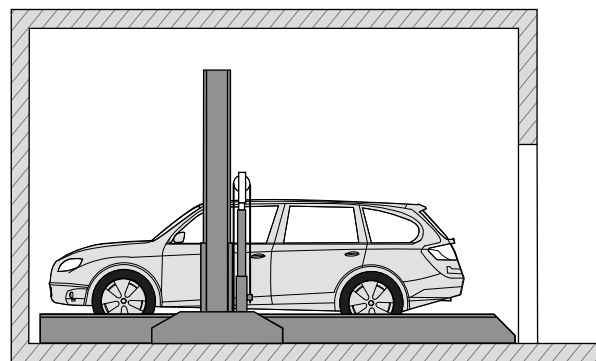

The upper vehicle can park in or leave the parking space.

## Dimensions and tolerances



All dimensions and minimum final dimensions.

Tolerance for dimensions +3/-0. Dimensions in cm.

In order to adhere to the minimum final dimensions, the tolerances in accordance with the German Construction Tendering and Contract Regulations [VOB], Part C (DIN 18330 and 18331) and DIN 18202 must also be taken into account.

## Overview of building configuration

### Building configuration without door

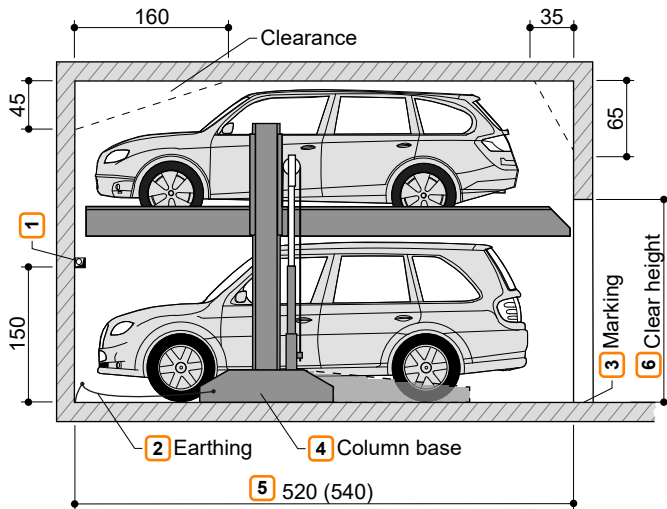

- 1 With dividing walls: Wall opening 10 x 10 cm
- 2 Equipotential bonding from foundation earth connection to system (to be provided by the customer).
- 3 In accordance with DIN EN 14010, the customer must provide 10 cm wide, yellow/black marking in accordance with DIN ISO 3864 in the access area in front of the contact area of the upper platform edge to identify the hazard area. (see "Loading schedule", page 7).
- 4 Variable column in two sizes (see "Loading schedule", page 7).

### Building configuration with door

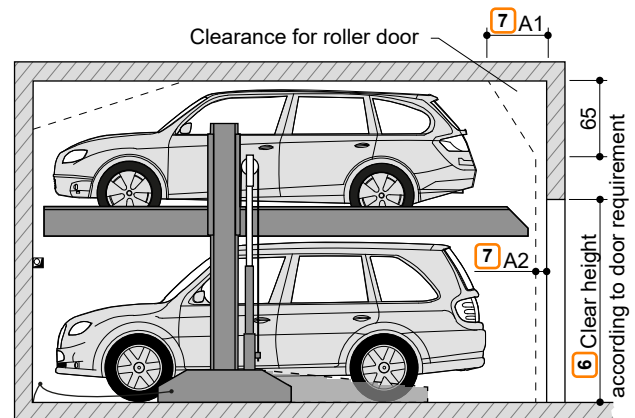

- 5 ■ 520 cm for vehicle length max. 5.0 m  
■ 540 cm for vehicle length max. 5.2 m  
Shorter versions are possible on request - observe local regulations on parking space lengths.  
We recommend a length of 540 cm for comfortable use of your parking space and increasingly longer vehicles.
- 6 Clear height in accordance with local regulations. Maximum vehicle height + 10 cm at a minimum.
- 7 Dimensions A1 and A2 must be coordinated between the door manufacturer and the customer.



The lower vehicle must exit before the platform is lowered.

## Vehicle data

### Version

SP (single platform) = 2 vehicles

### Parking options

Series vehicles:  
saloon, estate, SUV, van in accordance with clearance gauge and maximum parking space load.

	SP	
Weight 3	2000 kg	2600 kg
Wheel load	500 kg	650 kg

- 1 Vehicle height (see "Overview of system types and building heights", page 4)
- 2 Vehicle length (see "Overview of building configuration", page 3)
- 3 Space load can be subsequently upweighted to 2600 kg.

### Clearance gauge

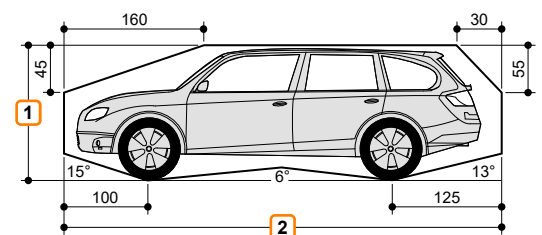

Vehicle width 190 cm with platform width 230 cm.  
Correspondingly wider vehicles can be parked with wider platforms.

## Overview of system types and building heights



Heights can be subsequently adjusted.

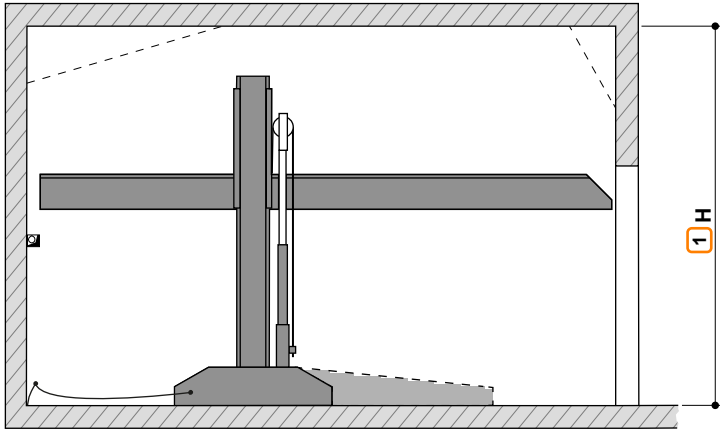

H: Building height

1 Where the ceiling height is greater, correspondingly higher vehicles may be parked at the top.

Type	Vehicle height, lower	Vehicle height, upper													H - Building height	
		150	155	160	165	170	175	180	185	190	195	200	205	210		215
2061-160	150	320	325	330	335	340	345	350	355	360	365	370	375	380	385	H
2061-170	160	330	335	340	345	350	355	360	365	370	375	380	385	390	395	
2061-180	170	340	345	350	355	360	365	370	375	380	385	390	395	400	405	
2061-190	180	350	355	360	365	370	375	380	385	390	395	400	405	410	415	
2061-200	190	360	365	370	375	380	385	390	395	400	405	410	415	420	425	
2061-210	200	370	375	380	385	390	395	400	405	410	415	420	425	430	435	

### Example configuration



Example: Vehicle height, lower 170 cm and vehicle height, upper 190 cm.

Type: 2061-180

Building height: 380 cm

Type	Vehicle height, lower	Vehicle height, upper													H	
		150	155	160	165	170	175	180	185	190	195	200	205	210		215
2061-160	150	320	325	330	335	340	345	350	355	360	365	370	375	380	385	H
2061-170	160	330	335	340	345	350	355	360	365	370	375	380	385	390	395	
2061-180	170	340	345	350	355	360	365	370	375	380	385	390	395	400	405	
2061-190	180	350	355	360	365	370	375	380	385	390	395	400	405	410	415	

## Width dimensions



We recommend platform widths of minimum 250 cm and driving lane widths of 650 cm in order that vehicles can comfortably access the Multiparking system and enter and leave without difficulty.

Narrower platforms may impede parking according to the following criteria.

- Driving lane width
- Entrance conditions
- Vehicle dimensions

- 1 Observe minimum driving lane width in accordance with local regulations.

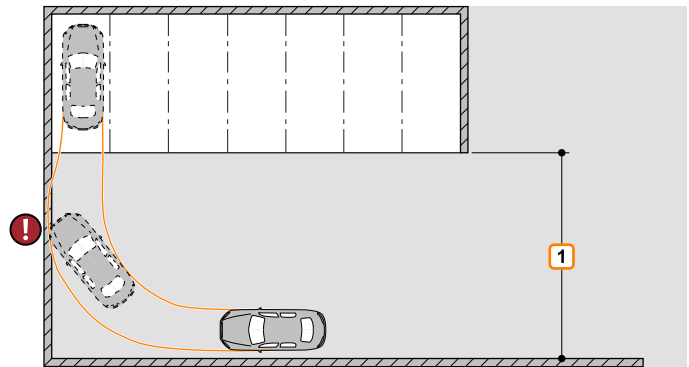

### Width dimension with door

	Single platform - SP		Double arrangement - 2x SP	
Support outside of the system area				
	<b>Clear platform width</b>	<b>Passage width B6</b>	<b>Clear platform width</b>	<b>Passage width B6</b>
SP	230	230	230	490
	240	240	240	510
	250	250	250	530
	260	260	260	550
	270	270	270	570
2x SP	230	490	230	490
	240	510	240	510
	250	530	250	530
	260	550	260	550
	270	570	270	570

- 1 The door section (dimension A3) must be coordinated between the door manufacturer and the customer. With lateral closing doors, coordination between the door manufacturer and KLAUS Multiparking is required.

Width dimension without door

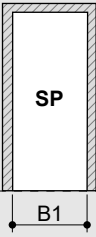
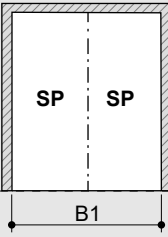
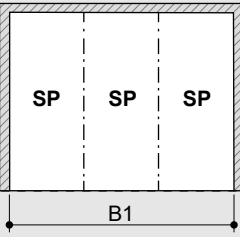
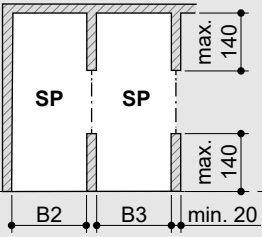
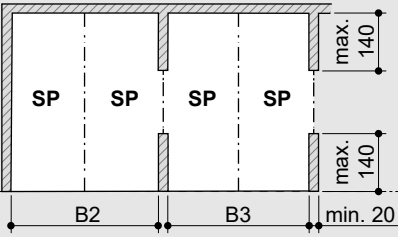
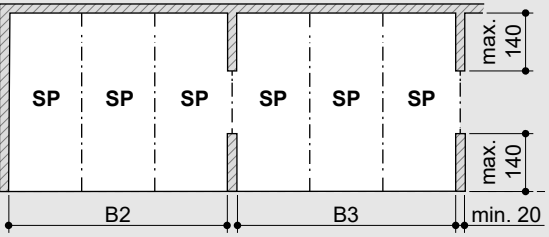
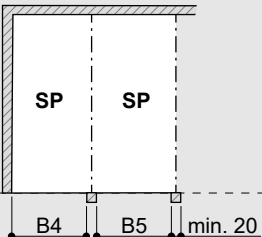
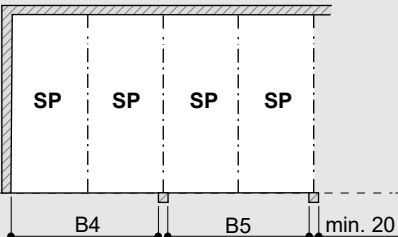
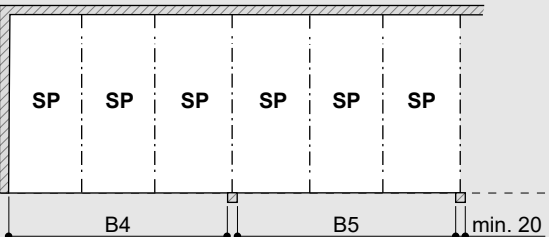
	Single platform - SP	Double arrangement - 2x SP	Triple arrangement - 3x SP			
<b>Dividing walls</b>						
<b>Support in the system area</b>						
<b>Support outside of the system area</b>						
	Clear platform width	Dividing walls B1	Support in the system area B2   B3		Support outside of the system area B4   B5	
<b>SP</b>	230	260	255	245	250	240
	240	270	265	255	260	250
	250	280	275	265	270	260
	260	290	285	275	280	270
	270	300	295	285	290	280
<b>2x SP</b>	230	520	515	510	510	500
	240	540	535	530	530	520
	250	560	555	550	550	540
	260	580	575	570	570	560
	270	600	595	590	590	580
<b>3x SP</b>	230	780	775	770	770	760
	240	810	805	800	800	790
	250	840	835	830	830	820
	260	870	865	860	860	850
	270	900	895	890	890	880

## Loading schedule



The systems are dowelled into the ground. The drill hole depth in the floor plate is approx. 15 cm, in the walls approx. 12 cm.  
The floor plate and walls must be from concrete (quality min. C20/25).  
The dimensions for the bearing points have been rounded. If the precise figures are required, please consult KLAUS Multiparking.

Column bases can be variably selected (short or long configuration). Always observe the corresponding forces.

### Variant 1 (V1): short column bases

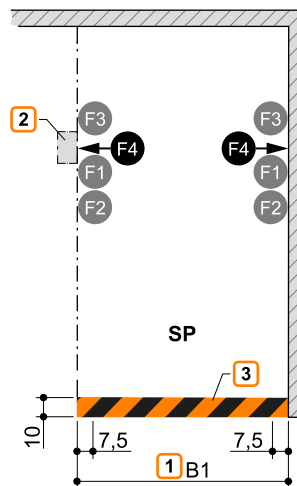
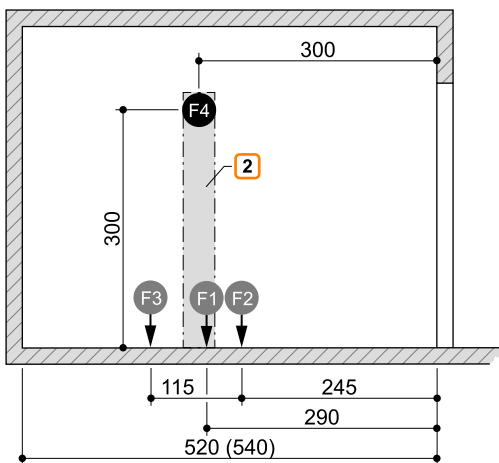

### Variant 2 (V2): long column bases

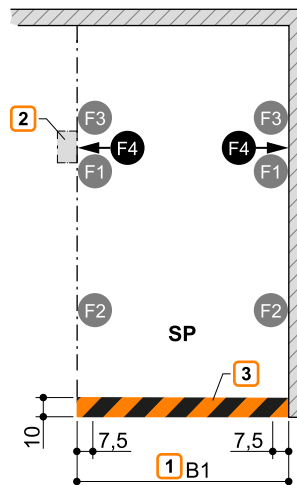
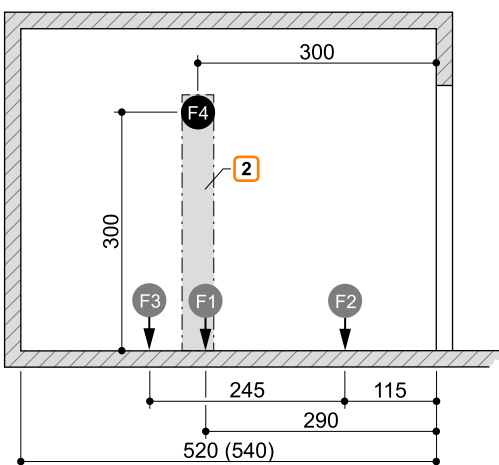

Parking space load	F1	F2	F3	F4	
V1	2000 kg	+ 30.0 kN	+ 1.1 kN	- 7.4 kN	± 1.0 kN
	2600 kg	+ 36.0 kN	+ 1.4 kN	+ 9.3 kN	± 1.0 kN
V2	2000 kg	+ 30.0 kN	+ 0.5 kN	+ 7.7 kN	± 1.0 kN
	2600 kg	+ 36.0 kN	+ 0.7 kN	+ 9.8 kN	± 1.0 kN

- 1 Width dimension B1 (see "Width dimension without door", page 6)
- 2 The system must be supported on both sides. An additional stand may be installed if there are no walls at the sides. A floor area of 50 x 30 cm is required for these standards (concrete quality min. C20/25, drill hole depth approx. 15 cm).
- 3 Marking in accordance with DIN ISO 3864 (illustration colour not consistent with DIN ISO 3864)

## Access incline



The maximum access inclines specified in the symbol sketch must not be exceeded. Improper configuration can lead to extreme difficulty accessing the system, for which KLAUS Multiparking cannot be held liable.

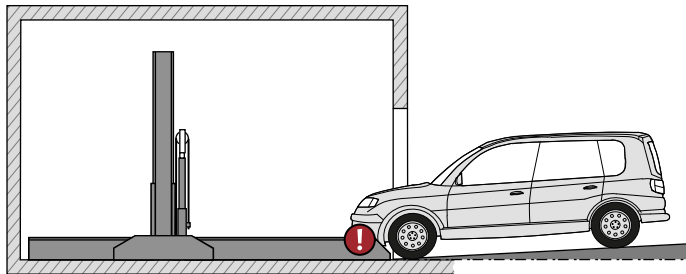

max. 4% slope

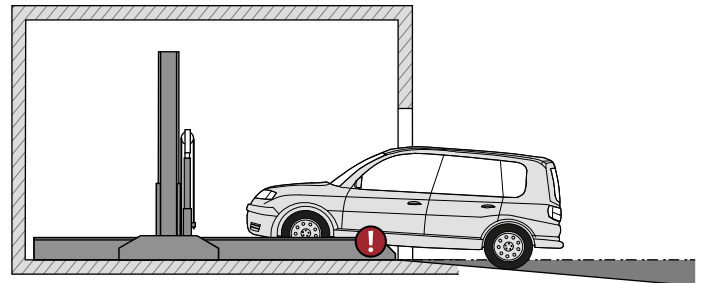

max. 14% gradient

## Clearance for installations



These clearances apply to vehicles parked forwards only, with exit on the left. The clearances must be adjusted for vehicles with exit on the right or parked in reverse.

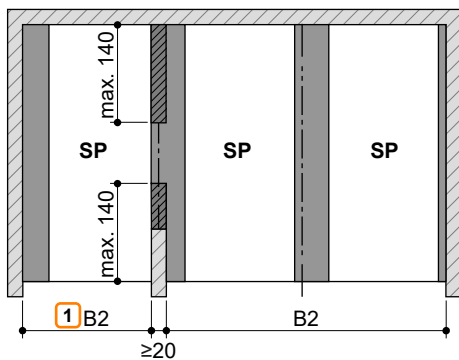
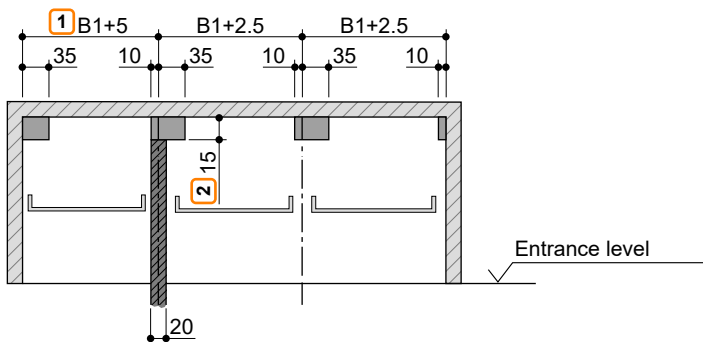

1 Dimensions B1 and B2 (see "Width dimension with door", page 5, "Width dimension without door", page 6)

2 Dimension 15 is reduced to 5 cm on type 2061-160.

- Clearance for lengthways cable routing
- Clearance for vertical pipes, air ducts, etc.



## Electrical installation

### Electrical installation diagram

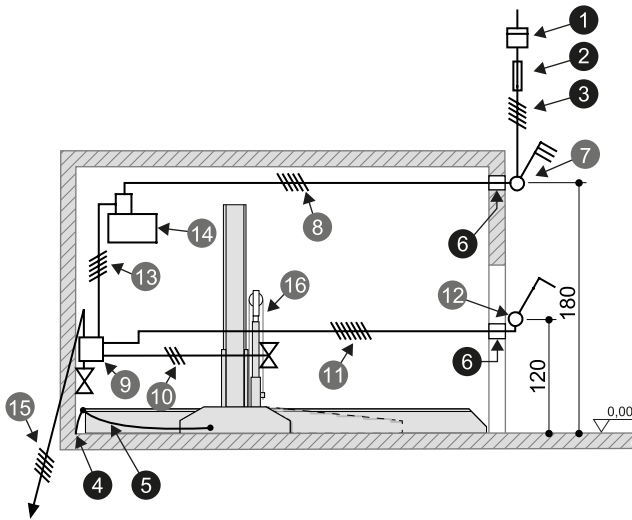

### On-site facilities for operating element

#### Surface-mounted operating element

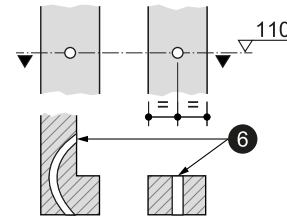

### Electrical specifications (services to be provided by the customer)

Nr.	Quantity	Designation	Position	Frequency
1	1	Power meter	in the supply cable	
2	1	Pre-fuse: 3x safety fuse 16 A (slow-blow) or Circuit breaker 3x 16 A (trip characteristic K or C)	in the supply cable	1x per unit
3	1	Supply cable 5 x 2.5 mm <sup>2</sup> (3 PH+N+PE) with marked wires and protective earth	to master switch	1x per unit
4	every 10 m	Foundation earth connection	Corner of the floor plate	
5	1	Equipotential bonding in accordance with DIN EN 60204 from foundation earth connection to system		1x per system
6	2	Empty pipe EN 25 (M25)		

### Electrical specifications (KLAUS Multiparking scope of supply)

Nr.	Designation
7	Lockable master switch
8	Supply cable 5 x 2.5 mm <sup>2</sup> (3 PH+N+PE) with marked wires and protective earth
9	Unit junction box
10	Control cable 3 x 0.75 mm <sup>2</sup> (PH+N+PE)
11	Control cable 7 x 1.5 mm <sup>2</sup> with marked wires and protective earth
12	Operating element
13	Control cable 5 x 1.5 mm <sup>2</sup> with marked wires and protective earth
14	Hydraulic unit 3.0 kW, three-phase current 230/400 V / 50 Hz
15	Control cable 5 x 1.5 mm <sup>2</sup> with marked wires and protective earth to next system
16	Chain monitoring

## CE conformity

The systems provided are consistent with DIN EN 14010 and the EC Machinery Directive 2006/42/EC. This system has also undergone a voluntary compliance test conducted by TÜV SÜD.

ZERTIFIKAT CERTIFICATE 認 証 証 書 CERTIFICADO CERTIFICAT	 Industrie Service	
	<h3>Certificate concerning the examination of conformity</h3>	
	<b>Certificate no:</b>	<b>KP 527</b>
	<b>Certification body:</b>	TÜV SÜD Industrie Service GmbH Zertifizierungsstelle für Produkte der Fördertechnik Gottlieb-Daimler-Str. 7 70794 Filderstadt - Germany
	<b>Applicant / Certification holder:</b>	KLAUS Multiparking GmbH Hermann-Krum-Str. 2 88319 Aitrach - Germany
	<b>Date of application:</b>	2016-08-16
	<b>Manufacturer:</b>	KLAUS Multiparking GmbH Hermann-Krum-Str. 2 88319 Aitrach - Germany
	<b>Product:</b>	Equipment for power driven parking of motor vehicles
	<b>Type:</b>	<b>SingleVario 2061 EB 2,000 kg</b> <b>SingleVario 2061 EB 2,600 kg</b>
	<b>Test laboratory:</b>	TÜV SÜD Industrie Service GmbH Prüflaboratorium für Produkte der Fördertechnik Prüfbereich Maschinen der Fördertechnik Gottlieb-Daimler-Str. 7 70794 Filderstadt – Germany
	<b>Date and number of the test report / mark of conformity:</b>	2017-02-20 <b>KP 527</b>
	<b>Test specifications:</b>	- 2006 / 42 / EC, Annex I - DIN EN 14010
	<b>Validity:</b>	<b>This Certificate is valid until 2022-02-28</b>
	<b>Result:</b>	The equipment fulfills the requirements of the test specifications for the respective scope of application stated in the annex (page 1) of this certificate, keeping the mentioned conditions.
<b>Date of issue:</b>	2017-03-01	
Certification body for lifts and cranes  Achim Janocha		
		
		

## Technical information

### Usage area

The system is suitable for a fixed group of users as standard. Where users change - in the upper parking spaces only - (e.g. short-term parking in office buildings or hotels), structural modifications to the Multiparking system are required. Please request a consultation if required.

### Units

Low-noise, bearing-mounted hydraulic units are installed on rubber-metal blocks. Consequently, we recommend separating the garage body from the residential building.

### Ambient conditions

Ambient conditions for the areas around Multiparking systems:  
 Temperature range -20 to +40 °C. Relative humidity 50% to a maximum external temperature of +40 °C.  
 If ascent/descent times are specified, these relate to an ambient temperature of +10 °C and with the system positioned immediately adjacent to the hydraulic unit. These times are increased at lower temperatures or with longer hydraulic lines.

### Building application documents

Multiparking systems generally require approval. Please observe local regulations and stipulations.

### Care

To prevent corrosion damage, please observe our special cleaning and care instructions and ensure that your garage is well ventilated.

### Corrosion protection

In accordance with the 'Corrosion protection' supplement.

### Railings

If there are roadways immediately adjacent to or behind the systems, the customer must provide barriers in accordance with DIN EN ISO 13857. This also applies during the construction stage.

### Noise protection

#### Standard noise protection:

In accordance with DIN 4109-1 Noise protection in high-rise - Section 9: Maximum sound pressure level in living and sleeping areas 30 dB (A). User noise is not subject to the requirements.

The following dimensions are required for adherence to this value:

- Noise protection package in accordance with quote/order (KLAUS Multiparking)
- Sound insulation dimension of the building structure of min.  $R'w = 57$  dB (service to be provided by the customer)

#### Increased sound protection (special agreement):

In accordance with DIN 4109-5 Increased noise protection in high-rise - Section 8:

Maximum sound pressure level in living and sleeping areas 25 dB (A). User noise is not subject to the requirements.

The following dimensions are required for adherence to this value:

- Noise protection package in accordance with quote/order (KLAUS Multiparking)
- Sound insulation dimension of the building structure of min.  $R'w = 62$  dB (service to be provided by the customer)

#### Note:

User noise is noise that can be influenced individually by the user of our Multiparking systems. This includes, e.g., accessing the platform, the slamming of vehicle doors, engine and brake noise.

## Performance specification

### Description

Multiparking system for dependent parking of 2 vehicles one on top of the other. The lower vehicle parks directly on the floor plate. The lower vehicle must exit before the platform is lowered.

The height of the platform can be flexibly adjusted (including subsequently). Upweighting to 2600 kg is subsequently possible.

Dimensions in accordance with the underlying building, width and height dimensions.

Access to the parking spaces horizontally (installation tolerance  $\pm 1\%$ ).

Vehicle positioning in the upper parking space by positioning aid mounted on one side (to be adjusted in accordance with the operating instructions).

Control via an operating element with automatic reset by means of simultaneous key.

Operating element usually installed in front of the support or on the outside of the door reveal.

Concise instructions at each operating point.

Special dimensions must be observed in buildings with door.

### Multiparking system comprising:

- 2 columns with column bases secured to the floor (short or long base configuration can be variably selected)
- 2 sliders (with sliding guides secured to the columns)
- 1 platform
- 1 mechanical synchronisation system (for synchronised operation of the hydraulic cylinders when lifting and lowering)
- 1 hydraulic cylinder
- Dowels, screws, connectors, bolts, etc.
- The platforms/parking spaces are continuously accessible.

### Platform comprising:

- Platform profiles
- Adjustable positioning aid
- Chamfered ramp
- Side beams
- Crossbeams
- Screws, nuts, washers, spacers, etc.

### Hydraulic system comprising:

- Hydraulic cylinders
- Magnetic valves
- Hydraulic lines
- Bolted connections
- High-pressure hoses
- Attachments

### Electrical system comprising:

- Operating element (emergency-stop, key, 1 simultaneous key per parking space)
- Junction box on wall valve
- Electrical locking
- Chain monitoring

### Hydraulic unit comprising:

- Hydraulic unit (low-noise, fitted to bracket and bearing mounted on rubber-metal block)
- Hydraulic oil tank
- Oil filling
- Internal gear pump
- Pump holder
- Coupling
- Three-phase motor
- Circuit protection (with thermal overload relay and control fuse)
- Test pressure gauge
- Pressure relief valve
- Hydraulic hoses (to attenuate noise transmission to the hydraulic pipes)

## Services to be provided by the customer

### Barriers

Barriers that may be required in accordance with DIN EN ISO 13857 where there are roadways immediately in front of, adjacent to or behind the systems. This also applies during the construction stage.

### Parking space numbering

Parking space numbering, if required.

### Building services systems

Any lighting, ventilation, fire-extinguishing and fire-alarm systems that may be required, plus clarification and compliance with corresponding official documentation.

### Lighting

The customer must observe local regulations pertaining to the illumination of parking spaces and roadways. In accordance with DIN EN 12464-1 'Light and lighting - Lighting of work places', an illumination level of min. 200 lx is recommended for the parking spaces and operating area of the system.

### Warning marking

In accordance with DIN EN 14010, the customer must provide 10 cm wide, yellow/black marking in accordance with DIN ISO 3864 in the access area in front of the contact area of the upper platform edge to identify the hazard area.

### Wall openings

Any wall openings that may be required should be in accordance with the sectional drawings (see "Overview of building configuration", page 3).

### Supply cable to master switch - foundation earth

The customer must lay the supply cable to the master switch during assembly. Functional capability can be checked by our engineers on site, in conjunction with the electronics engineer. If this is not possible during assembly for reasons attributable to the customer, the customer must commission an electronics engineer.

The customer must earth the steel structure with a foundation earth connection (earthing distance max. 10 m) and equipotential bonding in accordance with DIN EN 60204.

### Operating element

Empty conduits and recesses for the operating element (see "Electrical installation", page 9). Consultation with KLAUS Multiparking is required when using folding doors.

## Subject to technical changes

In the course of technical progress, KLAUS Multiparking shall be entitled to use newer or different technologies, systems, processes or standards to provide the services than initially offered, provided that this does not disadvantage the customer in any way.

Manufacturer:

**KLAUS Multiparking GmbH**

Hermann-Krum-Straße 2  
D-88319 Aitrach

Phone: +49 (0) 7565 508-0  
Fax: +49 (0) 7565 508-88  
info@multiparking.com

**www.multiparking.com**

Sales office:

